



Vehicle Recovery Electric Winch

17001AOR – 17000 lb. Winch w/ metal cable and roller fairlead

17011AOR – 17000 lb. Winch w/ synthetic rope and aluminum fairlead

Off-Road Winch

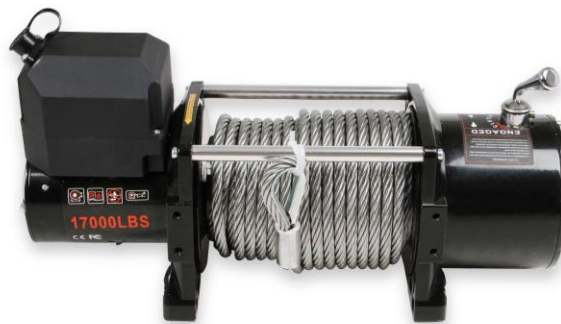

Operation Manual

Read before you install and use winch.

GENERAL INFORMATION:

This 12-volt electric winch is for pulling a load at ground level or up an incline. Do not use this winch for lifting or to move people. This winch is for intermittent use only, and will build up heat with use. If the motor on the winch becomes uncomfortably hot to touch, stop using the winch and allow it to cool down.

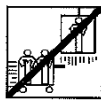

Read Owner's
Manual



Always Use
Hand saver

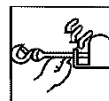

Keep clear of winch,
wire rope, and hook
while operating.

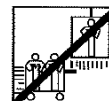

Never use winch
to lift or move
people.

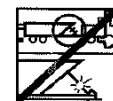

Never use winch
to hold loads in
place.

GENERAL SAFETY INFORMATION:

This winch is a very powerful machine. If the winch is used in an unsafe manner or used improperly, there is a possibility that property damage, or personal injury may result.

WARNING:

The operator of the winch is responsible for safe installation and operation of the winch (to prevent personal injury or property damage). Use good judgement and caution when operating the winch.

WARNING:

The synthetic rope or metal cable may break before the winch stalls. For heavy loads, use a pulley block to reduce the load on the rope or cable.

1. The maximum load capacity of the winch is when the rope or cable is on the first layer closest to the drum. Do not overload the winch, or attempt a prolonged pull at heavy load. Overloading the winch can damage it and/or damage the rope or cable & create unsafe operating conditions. For loads above half the rated capacity, use a pulley block. This will reduce load on the winch & rope or cable by 50 percent.
2. Read the instruction manual before installing and operating the winch. After installing the winch, practice using it so that you will be familiar with the operation when needed.
3. Keep the vehicle with the winch stationary, and do not move it to assist the winch in pulling a load. The combination of moving the vehicle & using the winch at the same time will overload the rope or cable.

4. Always stay clear of the rope or cable when using the winch. If the winch is used correctly and is not overloaded, it is unlikely that rope or cable will snap

5. Inspect the rope or cable frequently. Replace the rope or cable if it has frayed or broken strands.

6. Use heavy leather gloved when working with the winch. Do not let the rope or cable slide through your hands.

7. Never put your fingers in the hook, and use nylon safety lead (hand saver) to handle the rope or cable.

8. Never hook the rope or cable back onto itself since this will damage the rope or cable. Use a tree saver or tow strap to wrap around a tree or other attaching point.

9. Use a winch damper, blanket or jacket over the rope or cable near the hook when pulling heavy loads.

10. Avoid continuous pulls from extreme angles, since this cause the rope or wire to bunch up on one end of the drum. This can jamb up the rope or cable in the winch.

11. Always operate the winch with unobstructed view of the winching operation.

12. Equipment such as towing straps, hooks, pulley blocks, and other components must match the capacity of the winch & task. Replace any components that are damaged or worn.

13. Never release the free-spool clutch on the winch when there is a load on the winch.

14. Never work on or around the winch drum when the winch is under load.

15. Always disconnect the winch power leads to the battery before working on the winch, so that it cannot be turned-on accidentally.

16. Do not use the winch to hold loads in place. Use tie down straps to secure loads.

17. Use only the appropriate switches, remote controls, and other replacement parts.

18. Do not modify, weld, or machine any parts of the winch. Modifications can weaken the structural integrity of the winch.

19. Do not connect the winch to 110V or 220V AC household current (this winch is for use with 12V automotive battery only).

20. Use caution when using the winch. Keep people, pets, and property clear of the winch, rope, cable and path of the load.

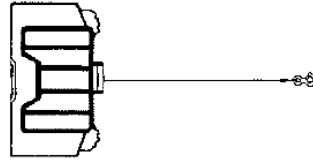

Single Line

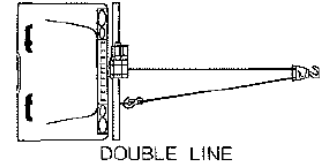

Double Line

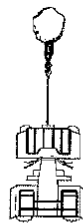
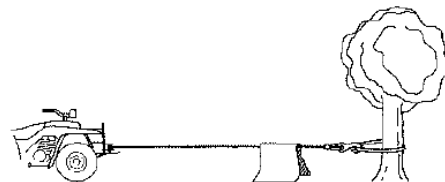
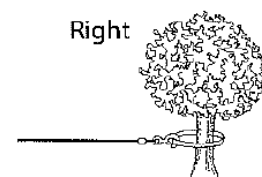
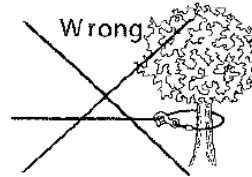
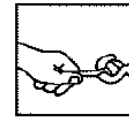
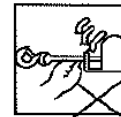

Right

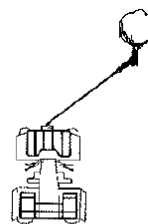

Wrong

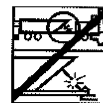
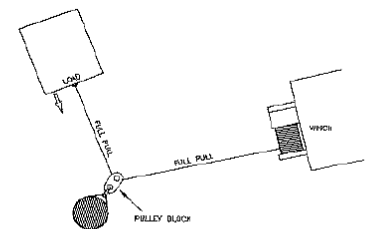

INSTALLATION:

1. Mount the winch with enough structural support for the capacity of the winch. This winch does not come with a mounting plate, but optional mounting plates are available separately.
2. Attach the fairlead to the mounting plate with the supplied hardware.
3. Mount the winch so that the rope or cable feeds into & out of the winch on the underside of the spool. Do not mount the winch backwards and attempt to reverse the operation of the winch by swapping the reverse & forward direction.
4. Disconnect the negative battery terminal on the vehicle, while wiring the winch.
5. Wire the winch using the wiring diagram shown below.
6. Free-Spool Operation – Turn the clutch handle to the free-spool position. Activate the winch in the Cable-out direction to check the drum rotation direction. If the drum rotates in the wrong direction, recheck the wiring. If there is load on the rope or cable, it may be difficult to engage or dis-engage the clutch (release the tension on the cable & it will be easier to operate the clutch).

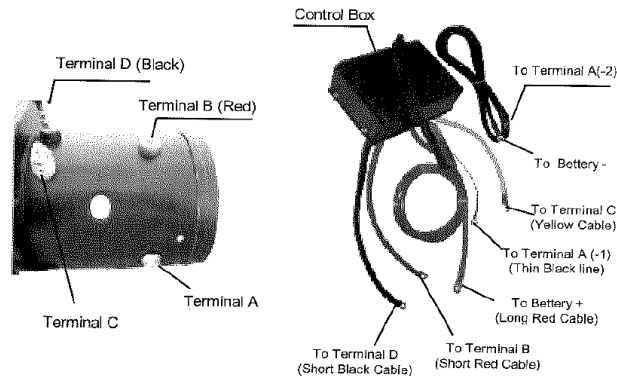

CAUTION:

The winch comes with wireless remote control, and the receiver for the remote control is inside the control box.

CAUTION:

The clutch must be engaged before using the winch to pull a load. Never engage the clutch when the drum is turning.

CAUTION:

If the winch motor stalls, do not continue to apply power.

OPERATION OF THE WINCH:

WARNING:

When the load exceeds to the maximum rated pulling power of the winch, the external circuit breaker will automatically shut down the winch. To reset the circuit breaker, release the switch and allow the winch to cool down

DANGER:

Never touch the rope, cable, or hook while they are in tension or under load. Even at rest, the winch may have tension on the rope or cable. Do not guide the rope or cable under tension onto the drum with your hands.

DANGER:

Wear heavy leather gloves when handling the rope or cable. Always use the nylon hook handle (hand saver) when handling the hook. Do not put your fingers in the hook.

CAUTION:

Use a pulley block to avoid winching at a sharp angle. The rope or cable will get damaged, if the load is pulled at an angle, since the rope or cable will get bunched up on one side of the drum.

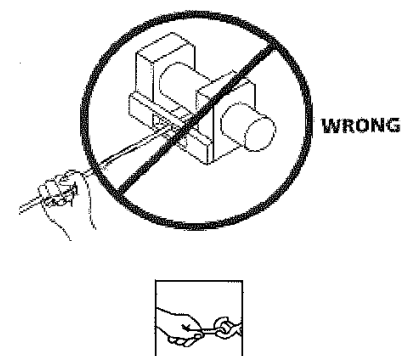

CAUTION:

Do not disengage the clutch with a load on the rope or cable. Release the tension, before operation of the clutch.

DANGER:

Never rely on the winch to hold a load in place. This winch is not for holding the load in place, and may unwind or fail due to shock loading during transport. Use tie downs for holding the load in place for transport.

DANGER:

Make sure that the rope or cable is wound around the drum at least 5 times before pulling a load. The rope or cable must come out of the winch from the bottom of the drum.

OPERATION OF WIRELESS REMOTE:

OPERATION OF WIRELESS REMOTE

Before you begin, you should familiarize yourself with our Wireless Remote Control and each of its functions.

Note: Turn off the remote to extend the battery life.

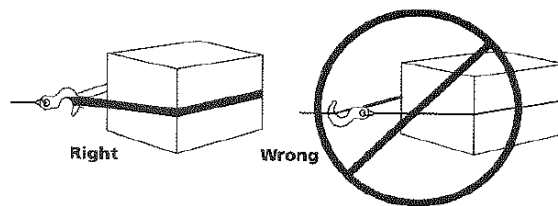
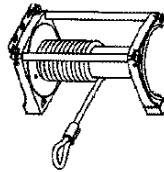
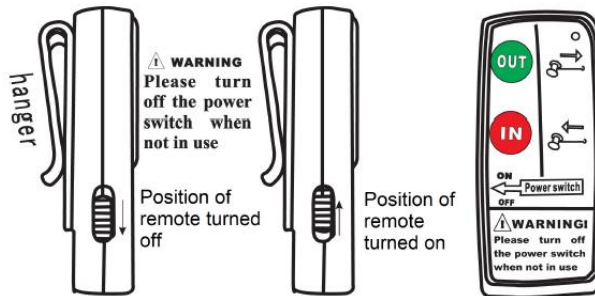

GENERAL USAGE RECOMMENDATIONS:

WARNING:

Use tow straps, hooks, and pulley blocks that match the capacity of the winch & load.

Never handle the rope or cable while someone else is operating the switch.

CAUTION:

Use a tow strap or tree saver on the load. Do not attach the hook back to the rope or cable, since this will damage or break the rope or cable.

Run the winch intermittently to take out the slack in the rope or cable. When using a pulley block, check to make sure the rope or pulley is operating the pulley before applying the tension.

WARNING:

Do not re-engage the clutch while the winch is running.

WARNING:

Always operate the winch with an unobstructed view of the winching operation. Do not cover or remove the warning labels and instructions on the winch.

TROUBLESHOOTING:

If the winch does not operate correctly, check for these common problems:

Trouble Shooting

Symptom	Possible Cause	Solution
Winch will not operate	Loose wiring or open circuit	Check wiring
	Weak battery or insufficient power	Recharge or replace battery
	Damaged overload protector	Replace overload protector
	Loose connection on wiring	Check wiring
	Damaged or stock solenoid	Replace solenoid
	Remote control will not work	Check "On & Off" switch position
	Damaged motor or worn brushes	Replace motor or brushes
Motor runs in one direction	Damaged wiring or bad connection	Reconnect or replace wiring
	Damaged or stock solenoid	Replace solenoid
	Switch does not work	Replace switch
Drum will not Free-spool	Free-spool dis-engaged	Engage free-spool
	Damaged brake or free-spool assembly	Replace brake or free-spool assembly
	Worn drum bushings	Replace drum bushings
	Damaged gear box	Replace gear box
No Brake	Damaged pressed-in spring	Replace pressed-in spring
	Dis-engaged free-spool	Engage free-spool
	Damaged output shaft	Replace output shaft
	Damaged first shaft	Replace first shaft
Winch runs in opposite direction.	Motor wiring switched	Reverse connections to motor
	Solenoid control wiring switched	Reverse black & red wires on solenoid
	Remote control or switch works backwards	Reverse connections to motor
Motor runs extremely hot	Long period of operation	Stop and allow motor to cool
	Overload	Reduce load or use pulley block
	Damaged brake	Replace or repair brake

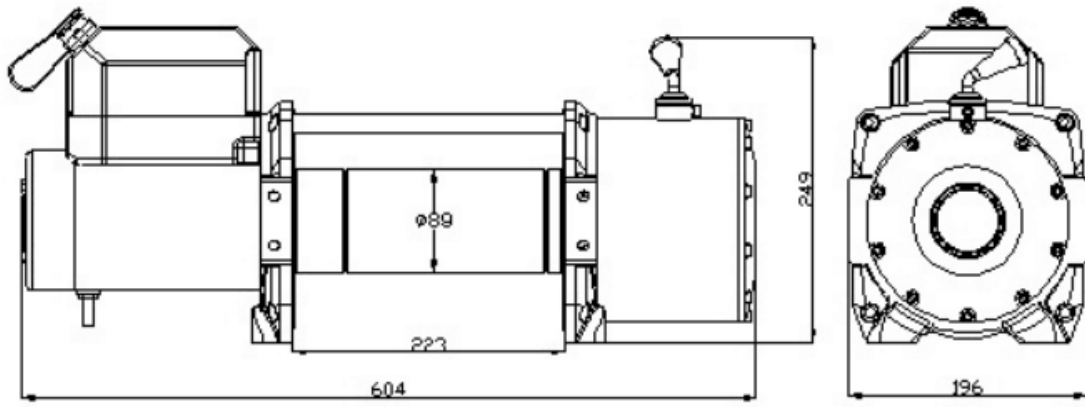
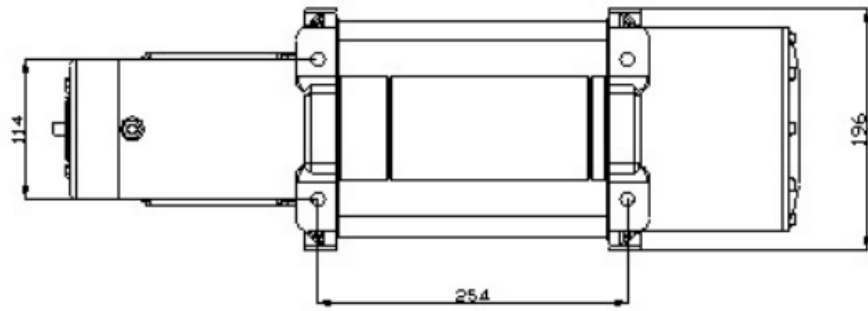

199R12038
Date: 3-25-20