



Installation Instructions

615128

2011-16 FORD F250/F350 TRUCKS 6.2L ENGINE

THIS INTAKE SYSTEM IS 50-STATE LEGAL FOR THE VEHICLES LISTED ABOVE PER CARB EXECUTIVE ORDER D-698-5. SEE WWW.FLOWMASTERMUFFLERS.COM FOR CARB STATUS OF INTAKE SYSTEMS FOR OTHER VEHICLES.

NOTE: ITEM 20 (1/4" NPT PLUG) IS AN OPTION THAT MAY BE USED IN PLACE OF EITHER FITTING 13 OR 15, DEPENDING ON YOUR VEHICLE'S CONFIGURATION. SEE INSTRUCTIONS FOR FURTHER DETAILS.

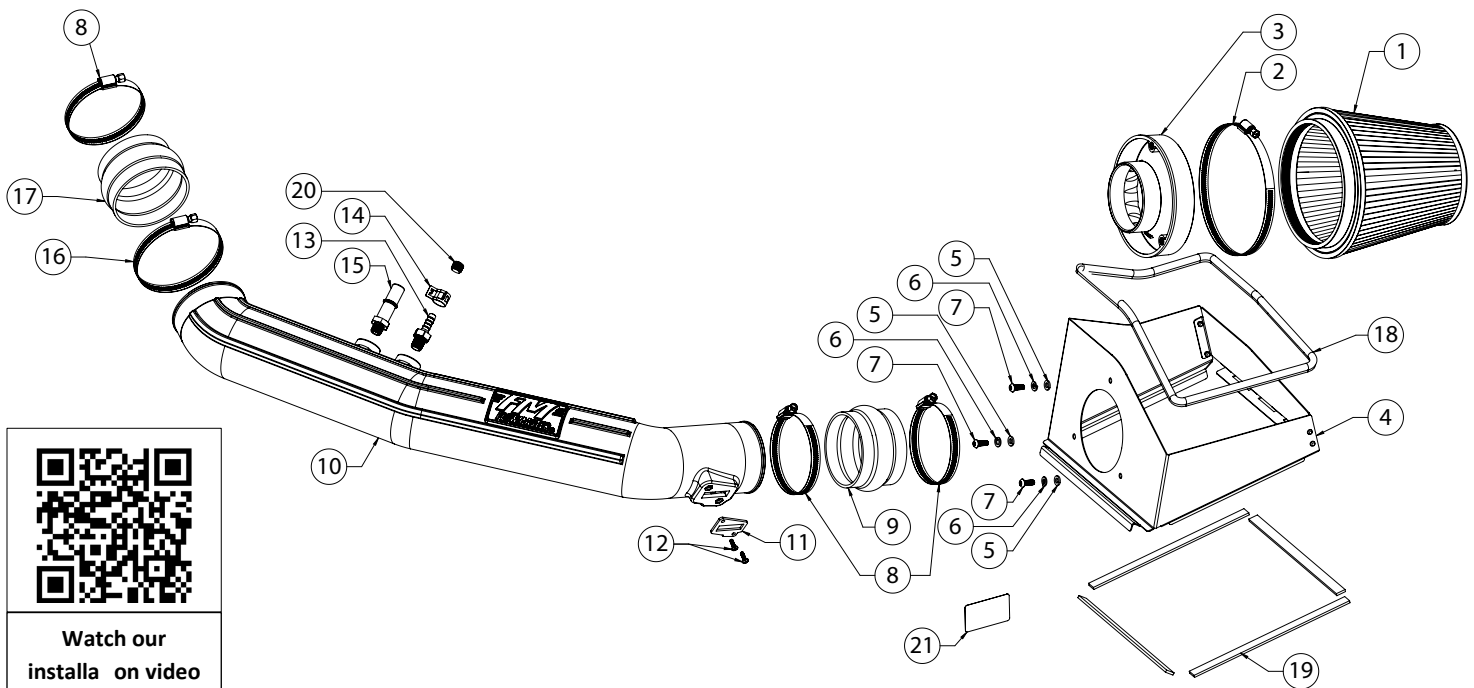

Watch our
installa on video
on YouTube

ITEM NO.	PART NUMBER	DESCRIPTION	QTY.
1	AF1002	AIR FILTER 7-1/2" x 6" DIA	1
2		SCREW CLAMP, #104 (4-1/8" - 7")	1
3	AF6001	ADAPTER, AIR FILTER 3-1/2" x 6"	1
4	AF3018	HEAT SHIELD	1
5	HW319	FLAT WASHER, M6	3
6	HW318	LOCK WASHER, M6	3
7	HW244	SCREW, M6 x 1.0 x 16MM	3
8	MC350H	SCREW CLAMP, #56 (3-1/16" - 4")	3
9	AF4019	COUPLER, FLEX 3-1/2" I.D. x 2-1/2" L	1
10	AF2025	INTAKE TUBE	1

ITEM NO.	PART NUMBER	DESCRIPTION	QTY.
11	GA139	GASKET, MAF SENSOR	1
12	HW248	SCREW, M4 x 0.7 x 12MM	2
13	AF4040	STRAIGHT FITTING, 3/8" BARB TO 1/4" NPT MALE	1
14	MC002P	PINCH CLAMP, 3/8" HOSE	1
15	AF4016	5/8" QUICK CONNECT TO 1/4" NPT MALE	1
16	MC400H	SCREW CLAMP, #64 (3-9/16" - 4-1/2")	1
17	AF4069	3.5"x3.75"x2.5" HUMP RUBBER COUPLER	1
18	49000061	GASKET, HEAT SHIELD	48"
19	49000067	SEAL STRIP, ADHESIVE, 1/8" x 1/2"	48"
20	AF4033	PLUG, 1/4" NPT	1
21	LB698-5	CARB EO LABEL, DELTA FORCE, D-698-5	1

REVIEW THE INSTRUCTIONS AND VERIFY THE KIT CONTENTS:

1. Please take a moment to read and understand these instructions before installing your Flowmaster performance air intake kit.



2. Use the parts drawing and list (front page) to verify your kit's contents.

In the unlikely event that any parts are missing, please contact FLOWMASTER Technical Support for replacements.

REMOVE THE FACTORY AIR INTAKE SYSTEM:

NOTES

- We highly recommend that you retain all factory air intake system parts.
- Please refer to vehicle manufacturer's recommendations regarding removal of factory components.
- Disconnecting the negative battery cable erases pre-programmed electronic memories. Write down all memory settings before disconnecting the negative battery cable. Some radios will require an anti-theft code to be entered after the battery is reconnected. The anti-theft code is typically supplied with your owner's manual. In the event your vehicle's anti-theft code cannot be recovered, contact an authorized dealership to obtain your vehicle's anti-theft code.

3. Turn off the vehicle's ignition and disconnect the negative battery cable.

NOTE

- On 2011-2013 models, the stock intake duct and resonator are two-pieces.
- On 2014-2016 models, the stock duct and resonator are one piece.

ALL MODEL YEARS:

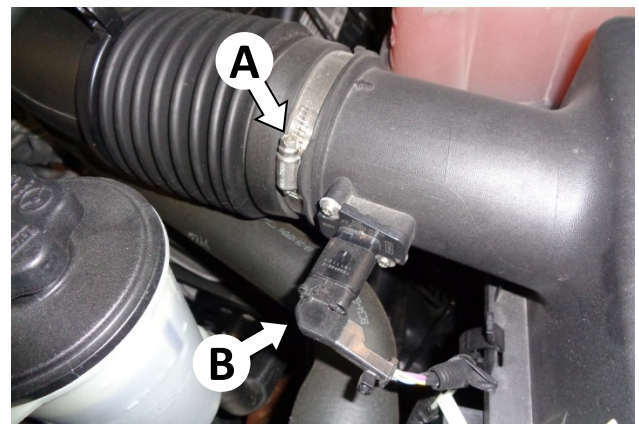

4. On the airbox cover, loosen the screw clamp (A). Then disconnect the mass airflow (MAF) sensor plug (B) by pulling the locking tab (on the bottom of the plug) away from the sensor until it stops, then squeezing the top and bottom of the plug and pulling it straight off the sensor.



5. Separate the intake duct from the airbox cover. Then release the three airbox cover latches and remove the cover and stock air filter from the vehicle.



6. Remove the MAF sensor from the airbox cover, then remove the factory gasket from the sensor. **CAUTION: The sensor is delicate!** Handle it with care, and put it in a safe place until reinstallation.

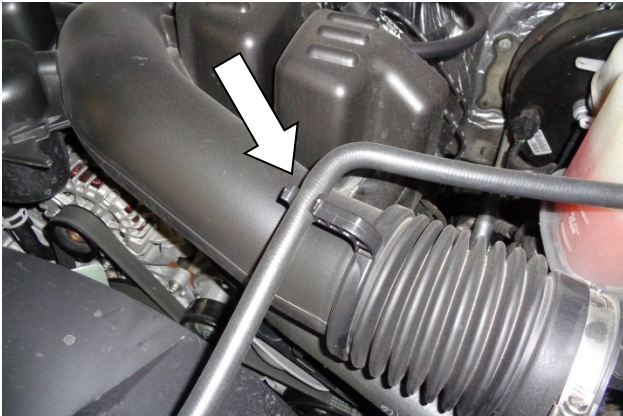

7. Release the coolant hose from the clip on top of the intake duct.

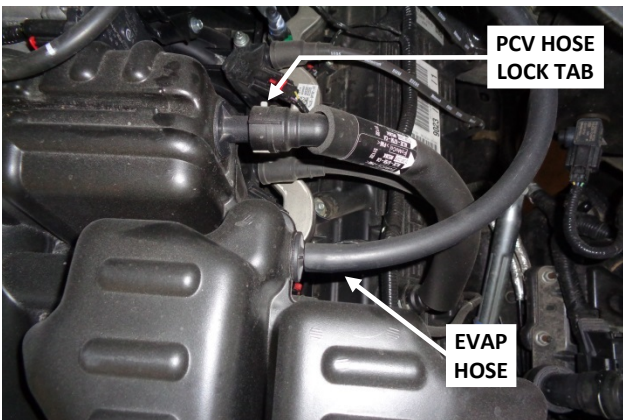

8. On the right side of the resonator, remove the EVAP and / or PCV vacuum hose(s). (Your vehicle may have either or both hoses.) **NOTE: Release the PCV fitting by releasing its locking tab.**

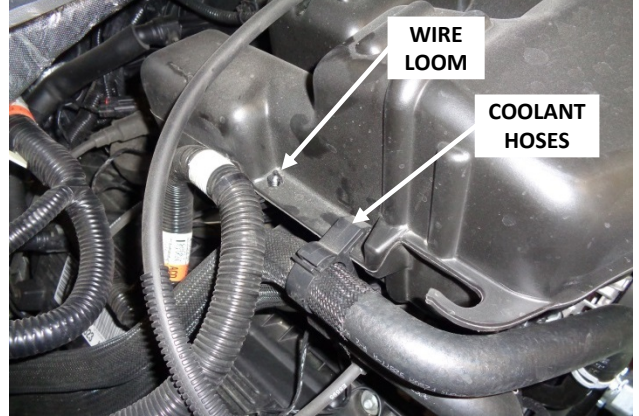

9. Use a flat-tipped screwdriver to carefully release the coolant hose clamp and (if applicable) the wire loom clamp on the left side of the resonator.

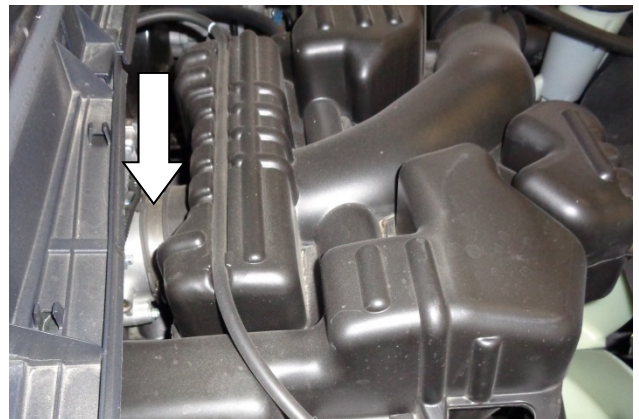

10. At the back of the resonator, loosen the screw clamp between the resonator and the throttle body.

2011 - 2013 MODELS (TWO-PIECE DUCT):



11. Loosen the screw clamp between the intake duct and resonator and remove the duct from the vehicle.

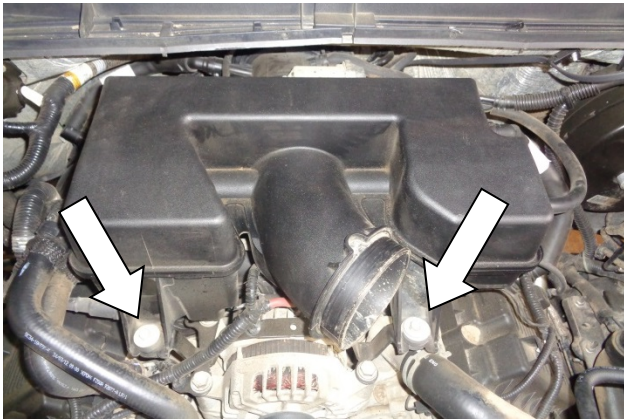

12. Remove the two bolts at the front of the resonator, then disconnect the resonator from the throttle body and remove it from the vehicle.

2014 - 2016 MODELS (ONE-PIECE DUCT):

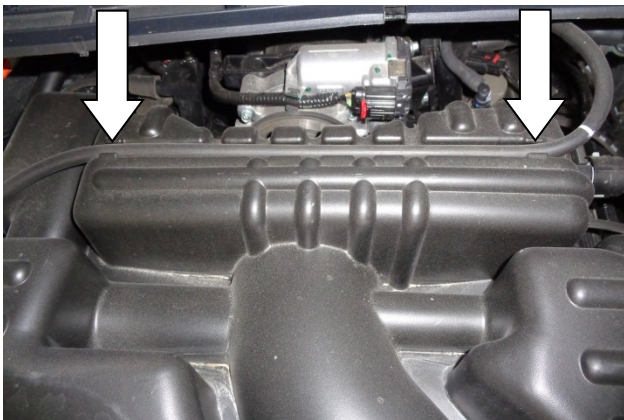

13. Release the vacuum hose from the recess across the top of the resonator. **NOTE: This hose must be properly secured after the Flowmaster performance air intake is installed. See Step 29.**

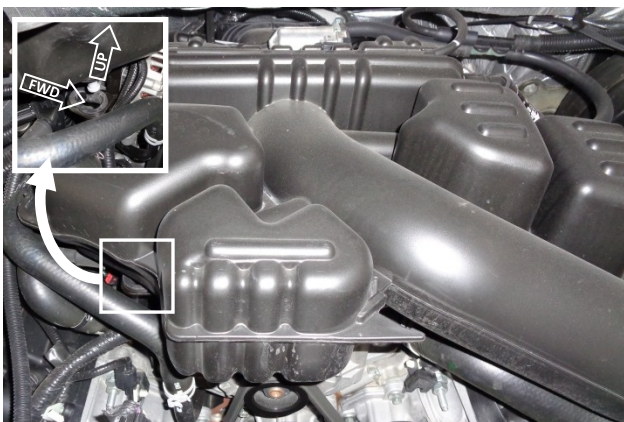

14. To release the duct-resonator from the throttle body, carefully work it side-to-side while pulling it forward. After it clears the throttle body, lift it upward to release its two mount pins from their grommets, and carefully remove it from the vehicle.

ASSEMBLE AND INSTALL YOUR FLOWMASTER PERFORMANCE AIR INTAKE SYSTEM:

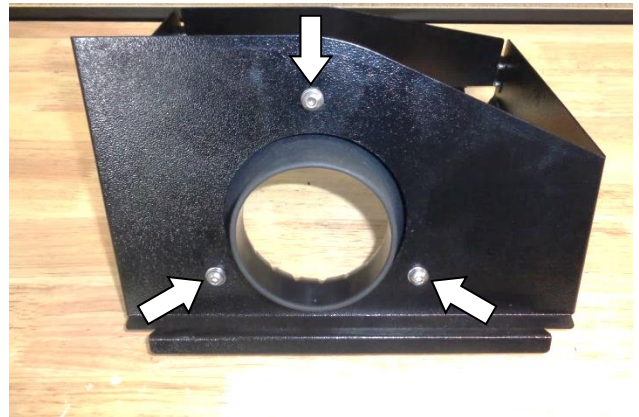

15. Assemble the air filter adapter (3) to the heat shield (4) using the M6 screws (7), lock washers (6) and flat washers (5).



16. Firmly press the gasket (18) onto the edge of the heat shield, gradually working your way around. When you return to the starting point, use metal-cutting shears to trim the gasket to length.

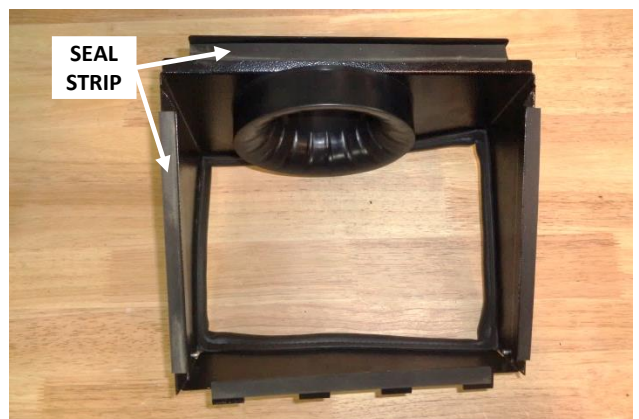

17. Cut the adhesive seal strip (19) to the lengths required, and apply it to the four bottom edges of the heat shield.



18. Place (x2) screw clamps (8) onto the 3-1/2" coupler (9). Install the coupler on the air filter adapter, pushing it flush against the heat shield. Tighten only the filter adapter clamp at this time. (Leave the other clamp loose.)



19. Slip screw clamp (2) onto air filter (1), then install the filter on the filter adapter and tighten the clamp.

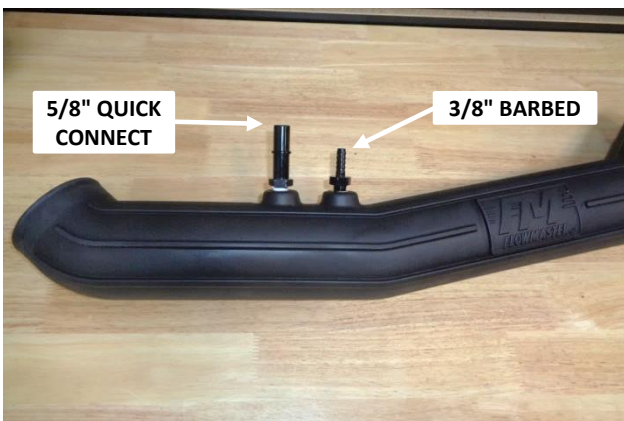

20. Your vehicle may require either the 5/8" quick connect fitting (15), or the 3/8" barbed fitting (13), or both. If it uses only one fitting, install the 1/4" plug (20) in the unused port. Apply 2 wraps of nylon thread tape to threads of the required hardware, and install them in the intake tube (10).



21. Install the MAF sensor gasket (11) over the sensor, then install the sensor in the intake tube, ensuring the correct orientation of the gasket and sensor to the mount pad. Secure the sensor using M4 screws (12).



22. Assemble the intake tube and heat shield. Only snug – do not tighten – the tube clamp at this time.



23. Place screw clamps (8) and (16) onto the coupler (17). Install the coupler on the other end of the intake tube. Only snug – do not tighten – the tube clamp at this time. (Leave the other clamp loose.)

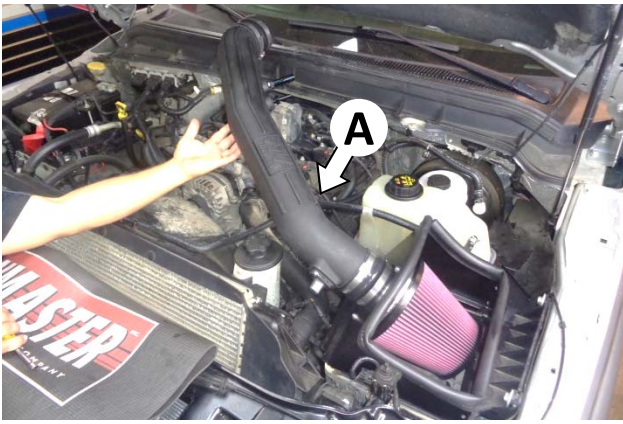

24. Insert the four tabs on the heat shield into the slots on the airbox, lower the intake tube into place, and slip the coupler onto the throttle body.
NOTE: The coolant overflow hose will pass under the new intake tube (A).



25. Secure the heat shield to the airbox with the three latches.

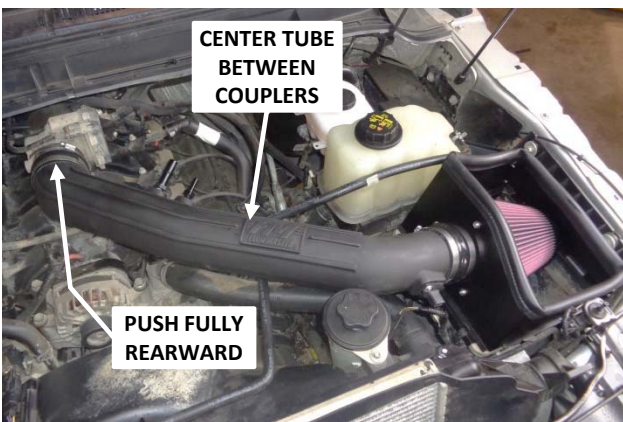

26. Push the rear coupler up against the stops on the throttle body, and tighten the throttle body clamp. Then center the intake tube between the couplers, and tighten the last two screw clamps.



27. Connect the PCV and / or EVAP hoses to their respective fittings, as applicable. Verify that the PCV connector is securely latched to the QD fitting. Secure the EVAP hose to the barbed fitting with the pinch clamp (14).



28. Reconnect the MAF sensor plug to the sensor, close the locking tab, and verify the connection is secure.

2014 - 2016 MODEL VEHICLES:

29. Secure the vacuum hose that was released from the resonator at Step 13, to prevent chafing or other damage to the hose or nearby components.



30. Affix the CARB Exemption Order label to a clean, readily-visible location under the hood (e.g., near the hood latch), so an inspector can easily see it at emissions testing.



Congratulations, the installation of your FLOWMASTER performance air intake kit is now complete!

VECI LABEL NOTE

California emissions law requires the Vehicle Emission Control Information (or VECI) label to be readily-visible in the engine compartment.

If your VECI label is affixed to the stock airbox, a replacement label must be obtained and affixed to a suitable location in the engine compartment.

Replacement VECI labels can be ordered from the dealership by VIN number. The VECI label should be affixed somewhere that is NOT easily removed from the vehicle.

NOTE: A missing VECI label may result in failure of the vehicle's emissions test.

FILTER MAINTENANCE:

We recommend that you clean and oil your air filter at 25,000 mile intervals using **Flowmaster's Filter Refresh Kit (PN 615001)**. See our website or your Flowmaster distributor for details.

IMPORTANT: RETAIN THESE INSTRUCTIONS FOR FUTURE REFERENCE

