

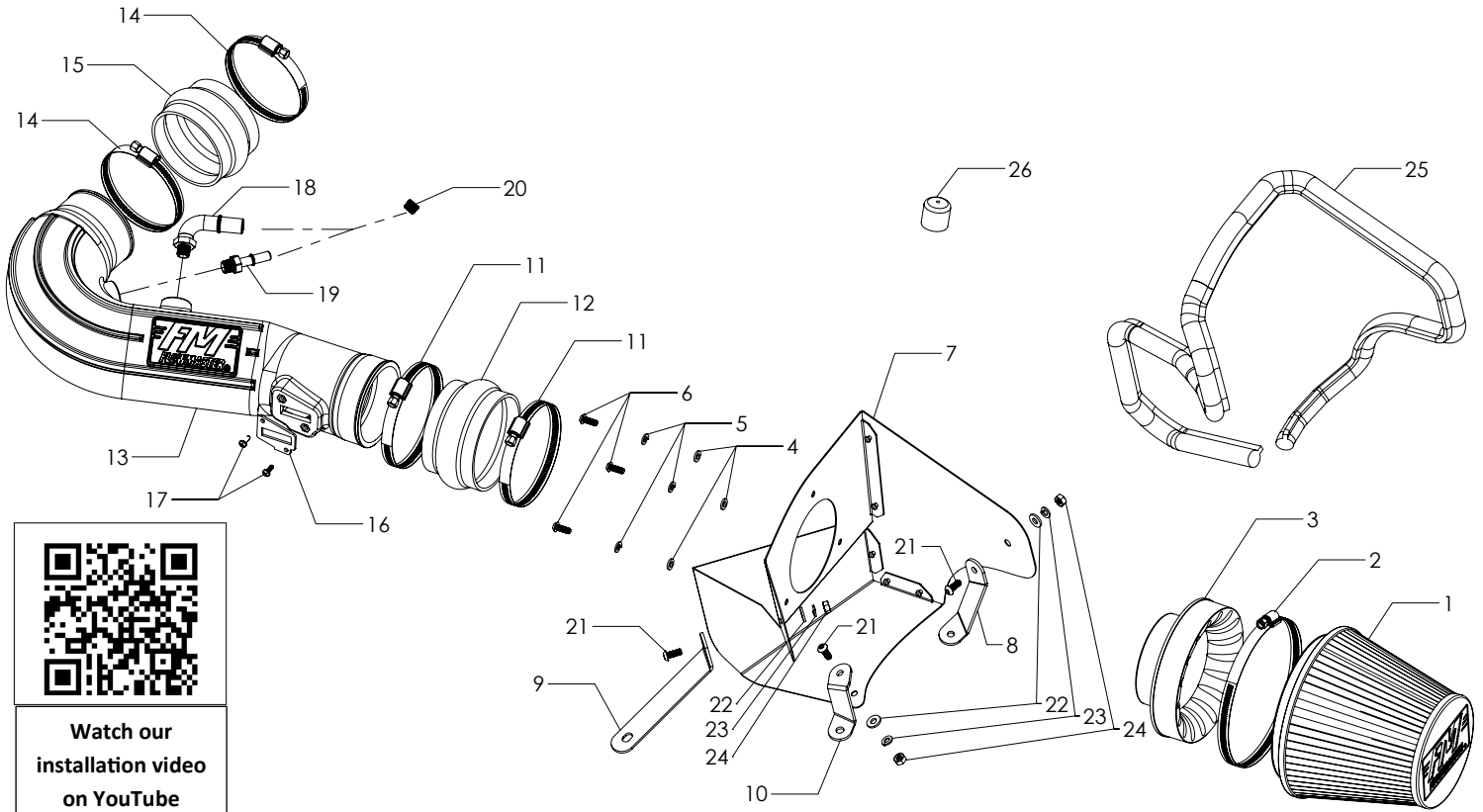

Installation Instructions 615130 2011-14 FORD MUSTANG 5.0L ENGINE

NOT LEGAL FOR SALE OR USE ON ANY POLLUTION-CONTROLLED MOTOR VEHICLE IN CALIFORNIA OR IN STATES THAT HAVE ADOPTED CALIFORNIA EMISSION PROCEDURES.



Watch our installation video on YouTube

NOTE: ITEM 20 (1/4" NPT PLUG) IS AN OPTION THAT MAY BE USED IN PLACE OF EITHER FITTING 18 OR 19, DEPENDING ON YOUR VEHICLE'S CONFIGURATION. SEE INSTRUCTIONS FOR FURTHER DETAILS.

2/4/2020

ITEM NO.	PART NUMBER	DESCRIPTION	QTY.
1	AF1003	AIR FILTER 6-5/8" x 6" DIA	1
2	AF1003	SCREW CLAMP, #104 (4-1/8" - 7")	1
3	AF6002	ADAPTER, AIR FILTER 4" x 6"	1
4	HW319	FLAT WASHER, M6	3
5	HW318	LOCK WASHER, M6	3
6	HW244	SCREW, M6 x 1.0 x 16MM	3
7	AF3019	HEAT SHIELD, 11-14 MUSTANG GT 5.0L	1
8	AF5026	BRACKET 1, 11-14 MUSTANG GT 5.0L	1
9	AF5027	BRACKET 2, 11-14 MUSTANG GT 5.0L	1
10	AF5028	BRACKET 3, 11-14 MUSTANG GT 5.0L	1
11	MC400H	SCREW CLAMP, #64 (3-9/16" - 4-1/2")	2
12	AF4009	COUPLER, FLEX 3-1/2" - 4" I.D. x 2-1/2" L	1
13	AF2015	MOLDED INTAKE TUBE, 11-14 MUSTANG GT 5.0L	1

ITEM NO.	PART NUMBER	DESCRIPTION	QTY.
14	MC350H	SCREW CLAMP, #56 (3-1/16" - 4")	2
15	AF4019	COUPLER, FLEX 3-1/2" I.D. x 2-1/2" L	1
16	GA139	GASKET, MAF SENSOR	1
17	HW248	SCREW, M4 x 0.7 x 12MM	2
18	AF4024	ELBOW, 90°, 5/8" QUICK CONNECT TO 1/4" NPT MALE	1
19	AF4017	STRAIGHT FITTING, 3/8" QUICK CONN TO 1/4" NPT MALE	1
20	AF4033	PLUG, 1/4" NPT	1
21	HW245	SCREW, 1/4"-20 x 5/8"	3
22	HW320	FLAT WASHER, 1/4"	3
23	HW322	LOCK WASHER, 1/4"	3
24	HW115	NUT, 1/4"-20	3
25	49000061	GASKET, HEAT SHIELD	72"
26	AF4020	CAP, VINYL, 1"	1

REVIEW THE INSTRUCTIONS AND VERIFY KIT CONTENTS:

1. Please take a moment to read and understand these instructions before installing your FLOWMASTER cold air intake kit.



2. Use the parts drawing and list (front page) to verify your kit's contents.

In the unlikely event that any parts are missing, please contact FLOWMASTER Technical Support for replacements.

To simplify assembly and avoid cross-threading fasteners, identify and separate the ¼-20 screws, (item 21) (used with nuts (24)), and the M6 screws (6) (used with filter adapter (3)).

REMOVE FACTORY AIR INTAKE SYSTEM:

NOTES

- We highly recommend that you retain all factory air intake system parts.
- Please refer to vehicle manufacturer's recommendations regarding removal of factory components.
- Disconnecting the negative battery cable erases pre-programmed electronic memories. Write down all memory settings before disconnecting the negative battery cable. Some radios will require an anti-theft code to be entered after the battery is reconnected. The anti-theft code is typically supplied with your owner's manual. In the event your vehicle's anti-theft code cannot be recovered, contact an authorized dealership to obtain it.

3. Turn off the vehicle's ignition and disconnect the negative battery cable.



4. If your vehicle includes an optional strut tower brace, remove the two nuts at each end of the brace and remove it from the vehicle.



5. Lift straight up on the front of the engine appearance cover to release it from its connectors, and remove it from the vehicle.

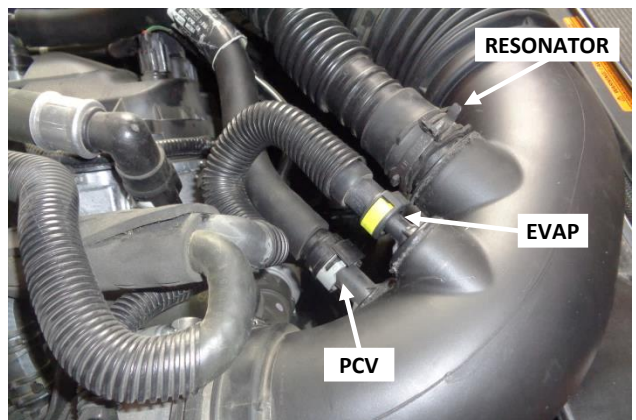

6. Disconnect the PCV and / or EVAP vacuum hose(s) from the intake duct. (Your vehicle may have either / both hoses.) Disconnect the resonator hose from the duct.

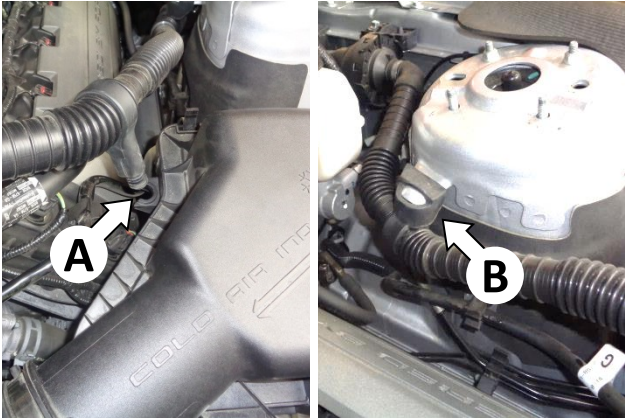

7. Pull the resonator hose clamps off of the air filter housing (A) and the strut tower (B).

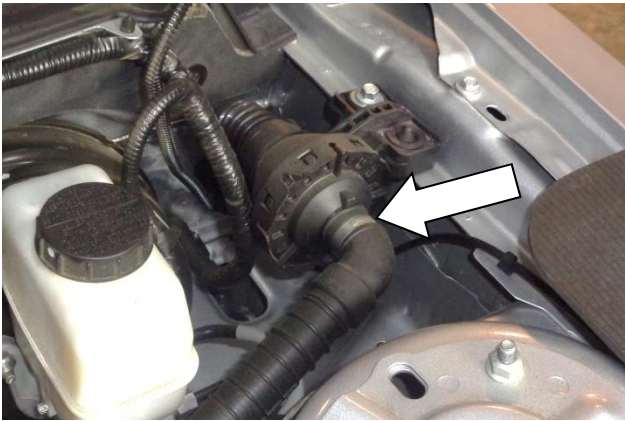

8. Cut and discard the resonator hose clamp, and remove the hose from the resonator.



9. Disconnect the mass airflow (MAF) sensor plug by pulling the locking tab (on the bottom of the plug) away from the sensor until it stops, then squeezing the top and bottom of the plug while pulling it straight off the sensor. Then release the clip securing the sensor lead to the airbox.

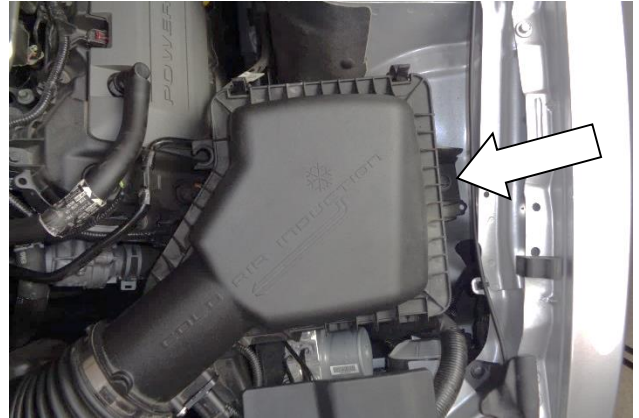

10. Remove the airbox mount bolt and **retain for use at Step 23.**

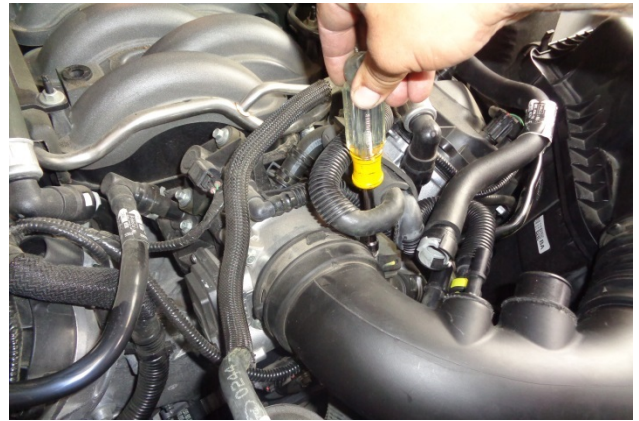

11. Loosen the screw clamp securing the intake duct to the throttle body, and separate the duct from the throttle body.



12. Remove the assembled airbox and duct from the vehicle.



13. Remove the MAF sensor from the airbox, then remove the stock gasket from the sensor.
CAUTION: The sensor is delicate! Handle it with care, and store it in a safe location until reinstallation.

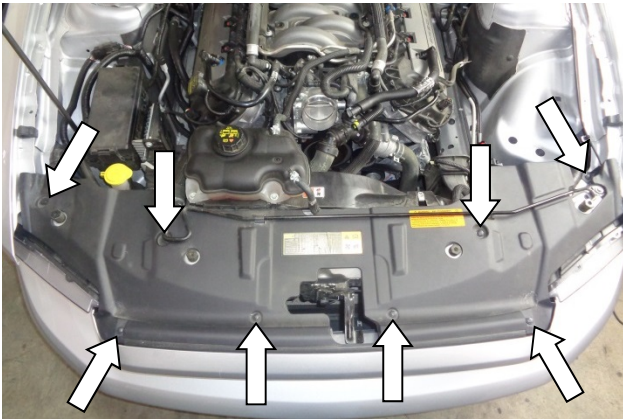

14. Identify the eight radiator support cover fasteners (plastic buttons) at the locations shown.



15. Remove each plastic fastener by using a flat-tip screwdriver to release its head, then removing the entire fastener (head and sleeve). **Retain fasteners for use at Step 34.**



16. After removing all eight fasteners, remove the radiator support cover.

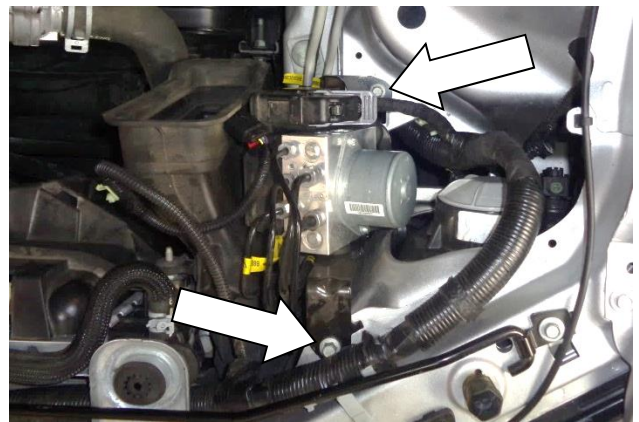

17. Remove the two bolts from the ABS modulator valve bracket and retain for use at Step 23.

ASSEMBLE AND INSTALL YOUR FLOWMASTER COLD AIR INTAKE SYSTEM:



18. Attach bracket (9) to heat shield (7) using $\frac{1}{4}$ -20 \times $\frac{5}{8}$ " screw (21) (against the bracket) and flat washer (22), lock washer (23) and nut (24) (against the heat shield). **Do not tighten the fasteners at this time.**

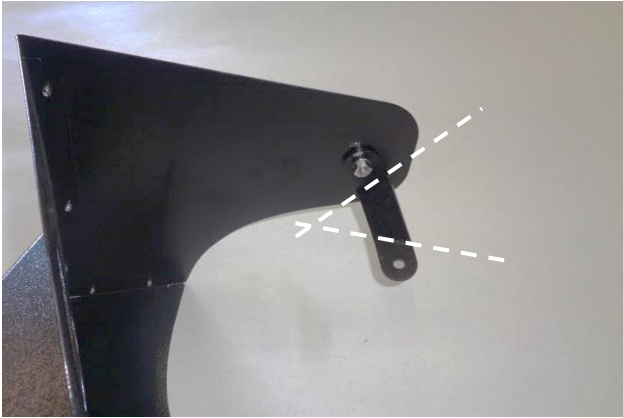

19. Attach bracket (8) to heat shield using ¼-20 × 5/8" screw (21) (against the bracket), and flat washer (22), lock washer (23) and nut (24) (against the heat shield). Note orientation of bracket bend lines. **Do not tighten the fasteners at this time.**



20. Attach bracket (10) to heat shield using ¼-20 × 5/8" screw (21) (against the bracket), and flat washer (22), lock washer (23) and nut (24) (against the heat shield). **Do not tighten the fasteners at this time.**

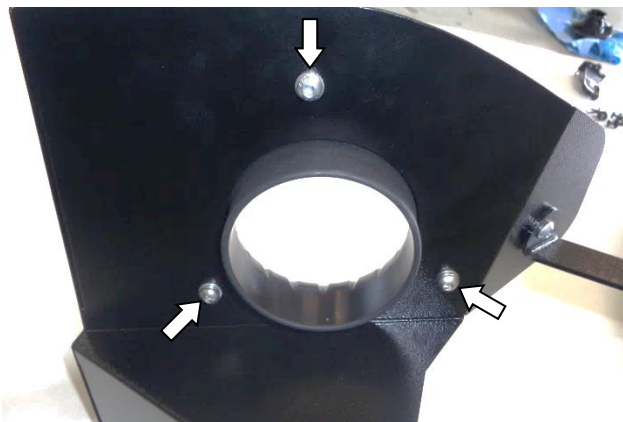

21. Assemble air filter adapter (3) to heat shield using M6 screws (6), lock washers (5) and flat washers (4).



22. Attach the gasket (25) to the heat shield. Starting on one side of bracket (10), gradually work around the heat shield, firmly pressing the seal onto the edge. When you return to the bracket, trim the gasket to fit using metal-cutting shears.

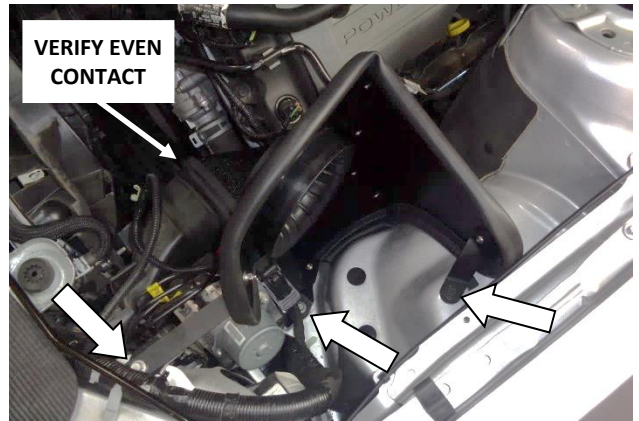

23. Install the assembled heat shield in the vehicle, securing the brackets with the **stock bolts removed at Steps 10 and 17**. Verify even contact between the heat shield gasket and the stock air duct seal. **Tighten all brackets to the heat shield at this time.**



24. Determine which vacuum fitting(s) are needed for your vehicle's configuration. The 5/8" elbow (18) mates with the PCV hose. The 3/8" straight (19) mates with the EVAP hose. **The 1/4" plug (20) will be installed if only one vacuum fitting is used.**



25. Apply 2 wraps of nylon thread tape to threads of the required fittings, and install them in the appropriate ports of the intake tube (13). Align the elbow with the intake tube's mold seam.



26. Slip the MAF sensor gasket (16) over the sensor, ensuring correct orientation. Then install the sensor in the intake tube, using the M4 screws (17).



27. Slip the two smaller screw clamps (14) onto the 3-1/2" flex coupler (15), and install the coupler on the discharge end of the intake tube. Only snug the clamps at this time, to allow adjustment when the tube is installed.



28. Slip the two larger screw clamps (11) onto the 3-3/4" - 4" flex coupler (12), and install the coupler's smaller opening on the intake end of the tube. Only snug the clamps at this time, to allow adjustment when the tube is installed.

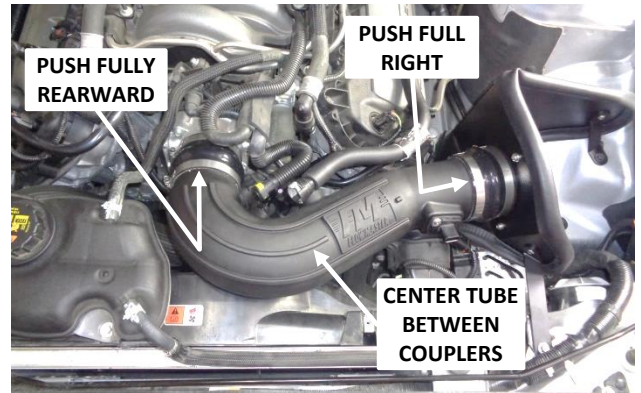

29. Install the intake tube in the vehicle. Push the left coupler fully up against the throttle body and tighten the clamp. Push the right coupler fully up against the heat shield and tighten the clamp. Then center the intake tube between the couplers, and tighten the last two clamps.



30. Connect the EVAP and / or PCV hoses to their respective fittings, as applicable, and verify that the connectors are securely latched to the fittings.



31. Plug the MAF sensor lead into the sensor, push the latch in, and verify the connector is secure.

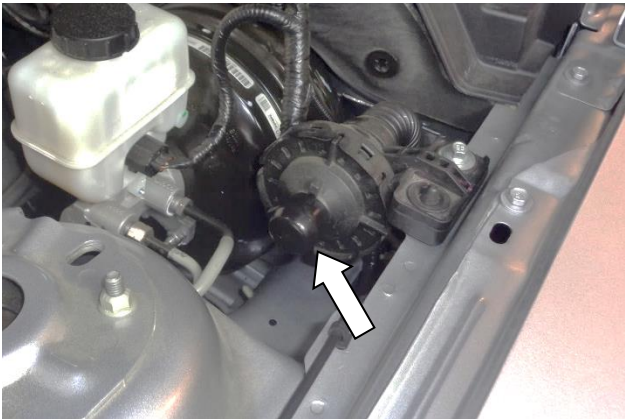

32. Install the vinyl dust cap (26) on the resonator.

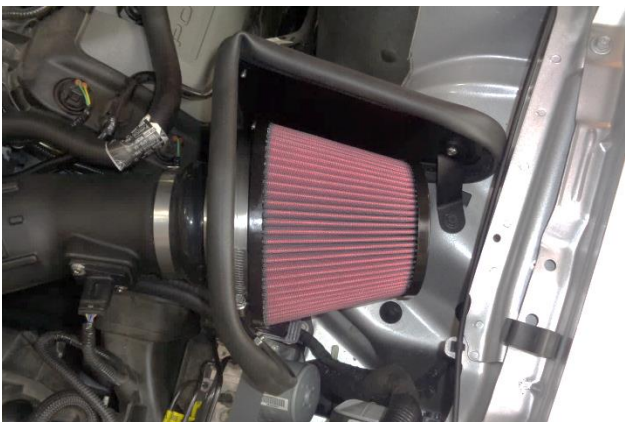

31. Install the clamp (2) on the air filter (1), then install the filter on the filter adapter and tighten the clamp.



34. Reinstall the radiator support cover and secure it with the **eight plastic fasteners removed at Step 15.**



35. Reinstall the engine appearance cover. If applicable, reinstall the strut tower brace, tightening the strut tower nuts to the torque value specified by the vehicle manufacturer.



Congratulations, the installation of your FLOWMASTER cold air intake kit is now complete!