



## Installation Instructions

# 615162

### 1997-04 FORD F-150, EXPEDITION

### 4.6L & 5.4L ENGINE

This kit is not designed to fit vehicles with a body lift.

THIS INTAKE SYSTEM IS 50-STATE LEGAL FOR THE VEHICLES LISTED ABOVE PER CARB EXECUTIVE ORDER D-698-5. SEE [WWW.FLOWMASTERMUFFLERS.COM](http://WWW.FLOWMASTERMUFFLERS.COM) FOR CARB STATUS OF INTAKE SYSTEMS FOR OTHER VEHICLES.

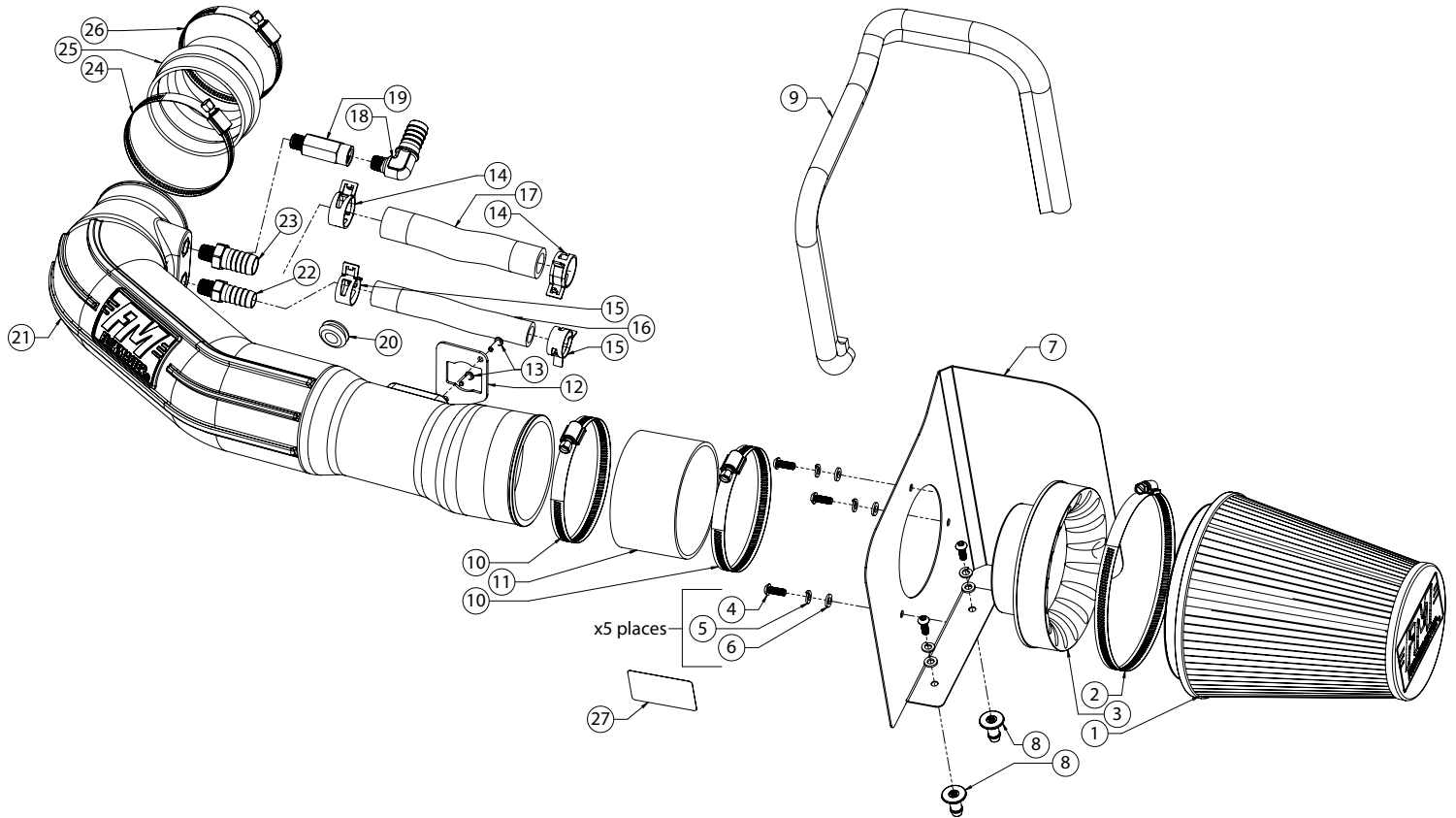

ITEM NO.	PART NUMBER	DESCRIPTION	QTY.
1	AF1001	AIR FILTER, 8-5/8" x 6" DIA	1
2	AF1001	SCREW CLAMP, #104 (4-1/8" - 7")	1
3	AF6002	ADAPTER, AIR FILTER 4" x 6"	1
4	HW244	SCREW, M6 x 1.0 x 16MM	5
5	HW318	LOCK WASHER, M6	5
6	HW319	FLAT WASHER, M6	5
7	AF3049	HEAT SHIELD	1
8	AF7001	BARBED PIN, M6 x 1.0	2
9	49000061	GASKET, HEAT SHIELD	48"
10	MC400H	SCREW CLAMP, #64 (3-9/16" - 4-1/2")	2
11	AF4050	COUPLER, STRAIGHT 4" I.D. x 2-1/2" L	1
12	GA146	GASKET, MAF SENSOR	1
13	HW259	SCREW, M4 x 0.7 x 16MM	2

ITEM NO.	PART NUMBER	DESCRIPTION	QTY.
14	MC005P	PINCH CLAMP, 3/4" HOSE	2
15	MC004P	PINCH CLAMP, 5/8" HOSE	2
16	49000068	HOSE, 5/8" I.D.	6"
17	49000063	HOSE, 3/4" I.D.	6"
18	AF4014	ELBOW, 90°, 3/4" BARB TO 1/4" NPT MALE	1
19	AF4068	FITTING, STRAIGHT 1/4" NPT M TO 1/4" NPT F	1
20	AF4008	GROMMET, 1-1/16" OD x 1/2" ID x 3/16" THK	1
21	AF2049	INTAKE TUBE	1
22	AF4032	FITTING, STRAIGHT 5/8" BARB TO 1/4" NPT M	1
23	AF4013	FITTING, STRAIGHT 3/4" BARB TO 1/4" NPT M	1
24	MC350H	SCREW CLAMP, #56 (3-1/16" - 4")	1
25	AF4057	COUPLER, FLEX 3-1/2" I.D. - 3" I.D. x 2-1/2" L	1
26	MC314H	SCREW CLAMP, #52 (2-13/16" - 3-3/4")	1
27	LB698-5	CARB EO LABEL D-698-5	1

## REVIEW THE INSTRUCTIONS AND VERIFY THE KIT CONTENTS:

1. Please take a moment to read and understand these instructions before installing your Flowmaster performance air intake kit.



2. Use the parts drawing and list (front page) to verify your kit's contents.

In the unlikely event that any parts are missing, please contact Flowmaster Technical Support for replacements.

## REMOVE THE FACTORY AIR INTAKE SYSTEM:

### NOTES

- We highly recommend that you retain all factory air intake system parts.
  - Please refer to vehicle manufacturer's recommendations regarding removal of factory components.
  - Disconnecting the negative battery cable erases pre-programmed electronic memories. Write down all memory settings before disconnecting the negative battery cable. Some radios will require an anti-theft code to be entered after the battery is reconnected. The anti-theft code is typically supplied with your owner's manual. In the event your vehicle's anti-theft code cannot be recovered, contact an authorized dealership to obtain your vehicle's anti-theft code.
3. Turn off the vehicle's ignition and disconnect the negative battery cable. **Failure to disconnect the battery may cause the CHECK ENGINE light to illuminate after the air intake kit is installed.**

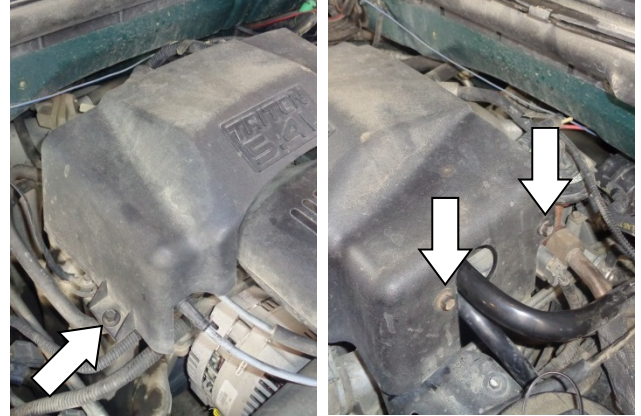

4. On the engine appearance cover, lift the access panel and remove. Then remove the screw and appearance cover.

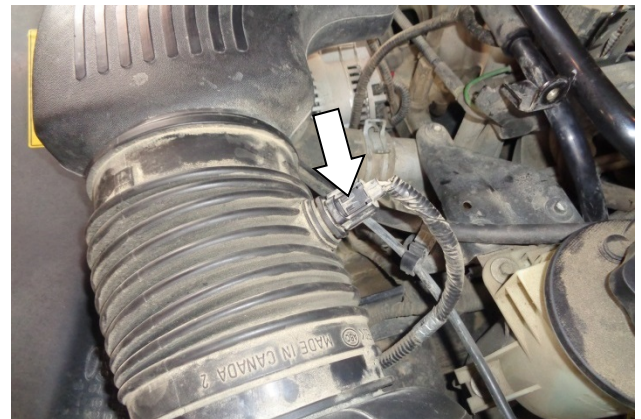

5. Disconnect the inlet air temperature sensor plug by depressing the latch and pulling the plug straight off the sensor.

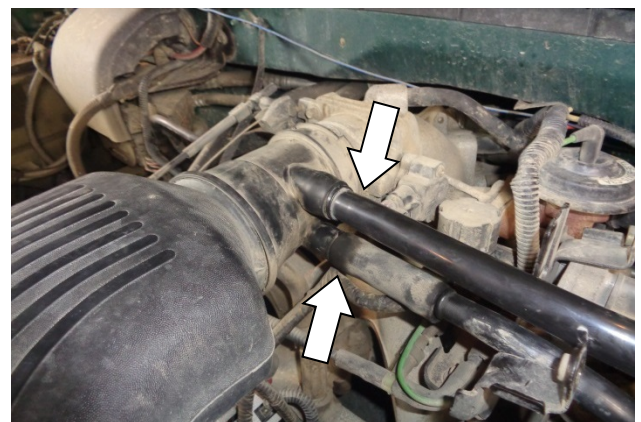

6. **ON 5.4L ENGINES:** Disconnect the idle air control and PCV tubes from the inlet duct. Remove the stock hose from the lower tube

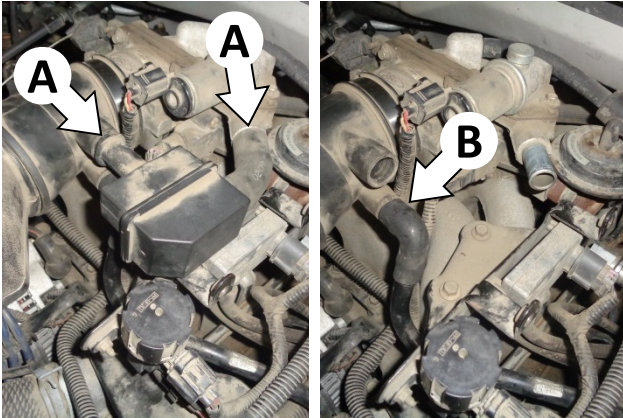

7. **ON 4.6L ENGINES:** Remove the air bypass valve from the vehicle at (A), then disconnect the PCV tube (B) from the inlet duct.

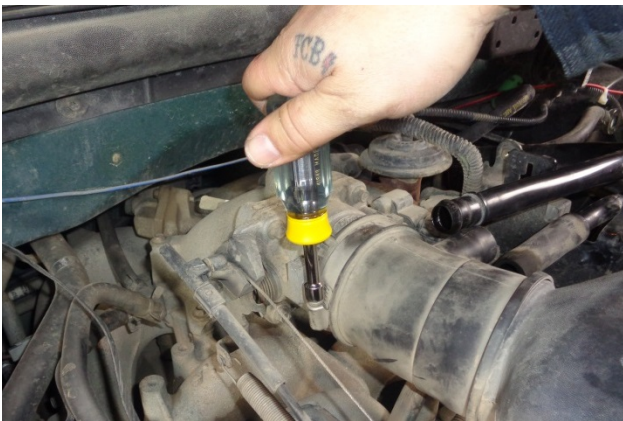

8. Loosen the screw clamp that secures the air inlet duct to the throttle body, and separate the duct from the throttle body.



9. Release the clamp at the middle of the airbox.

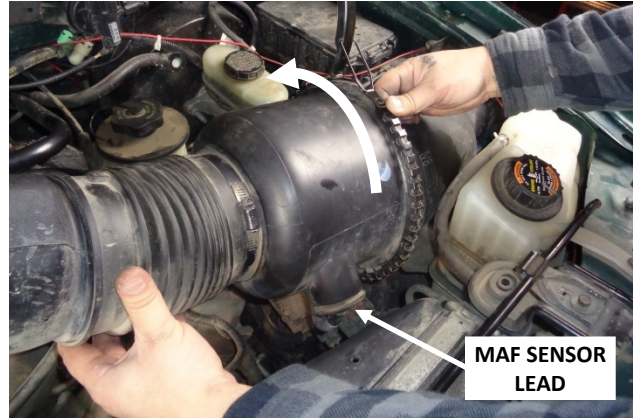

10. Separate the airbox halves. Carefully lift and rotate the air duct to gain access to the Mass Airflow (MAF) sensor lead grommet.



11. Carefully pull the MAF sensor lead grommet out of the airbox.



12. Use a small flat-tip screwdriver to release the latch on the MAF sensor plug, and disconnect the plug from the sensor.



13. After the plug is disconnected from the sensor, remove the inlet duct from the vehicle.



14. Remove the air cleaner from the airbox. Then remove the airbox from the vehicle by firmly pulling it straight up, out of its two mount grommets.

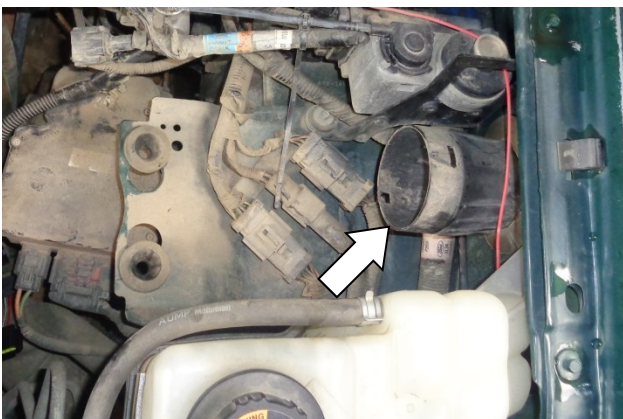

15. If the inlet snorkel did not come out of the fender wall with the airbox in the last step, remove it.



16. Firmly grasp and twist the air inlet temp sensor, and pull it from the inlet duct.

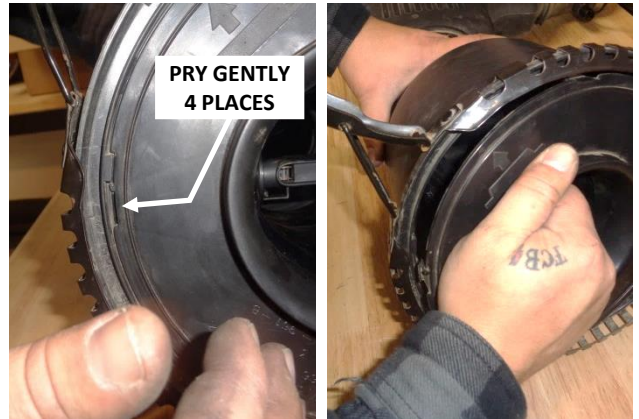

17. Use a small flat-tip screwdriver at 4 places to release the MAF sensor duct from the airbox, then remove the duct from the airbox.



18. Remove the MAF sensor from the duct (TR20 tamper-resistant Torx bit required), then remove the sensor's o-ring.

**ASSEMBLE AND INSTALL YOUR FLOWMASTER PERFORMANCE AIR INTAKE SYSTEM:**

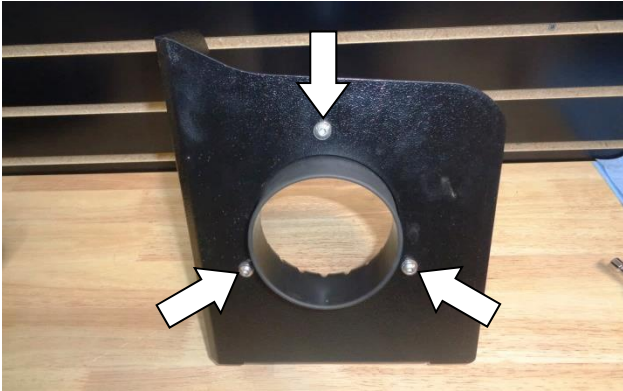

19. Assemble the air filter adapter (3) to the heat shield (7) using M6 screws (4), lock washers (5) and flat washers (6).

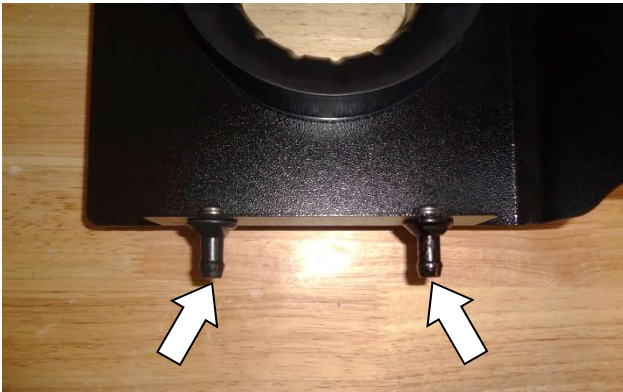

20. Attach the barbed pins (8) to the heat shield using M6 screws (4), lock washers (5) and flat washers (6).



21. Attach the gasket (9) to the heat shield. Starting at one end, firmly press the gasket onto the edge of the heat shield, gradually working all the way around. When you return to the other end, trim the gasket to fit using metal-cutting shears.



22. Install the 2 large screw clamps (10) on the 4" straight coupler (11). Then install the coupler on the filter end of the intake tube (21). **Do not tighten the clamps at this time.**



23. Install the medium screw clamp (24) and small screw clamp (26) on the 3-1/2" - to - 3" coupler (25). Then install the coupler on the throttle body end of the intake tube. **Do not tighten the clamps at this time.**



24. Install the MAF sensor gasket (12) onto the sensor, ensuring correct orientation. Then install the sensor in the intake tube, using the M4 screws (13).



25. Insert the rubber grommet (20) into the tube, then install the air temp sensor in the grommet. Moistening the items with soapy water will ease insertion, but do not get the sensor tip wet.

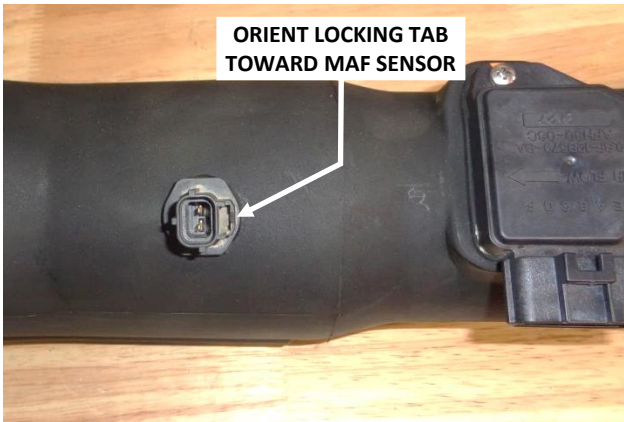

26. Orient the temp sensor's locking tab toward the MAF sensor.

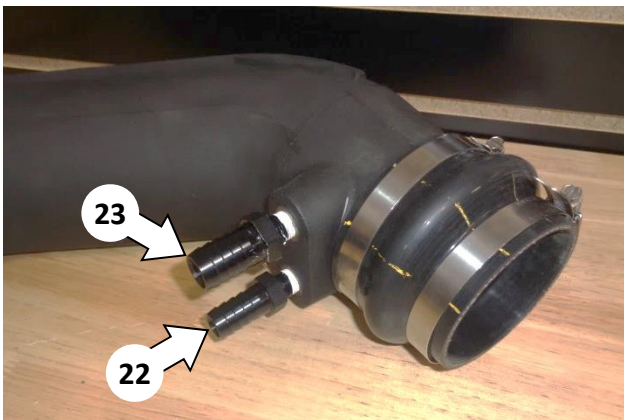

27. **ON 5.4L ENGINES:** Apply 2 wraps of nylon thread tape to the threads of the 3/4" barbed fitting (23) and 5/8" barbed fitting (22), and install them in the intake tube as shown.



28. **ON 4.6L ENGINES:** Apply 2 wraps of nylon thread tape to the threads of the 1/4" male to 1/4" female fitting (19), the 3/4" elbow (18), and the 5/8" barbed fitting (22), and install them in the intake tube as shown.



29. Install the assembled heat shield in the vehicle by pushing the two barbed pins into the grommets.

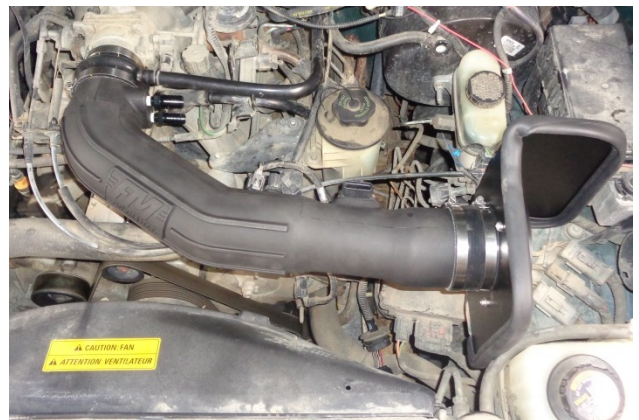

30. Install the intake tube in the vehicle, but do not tighten any screw clamps yet.

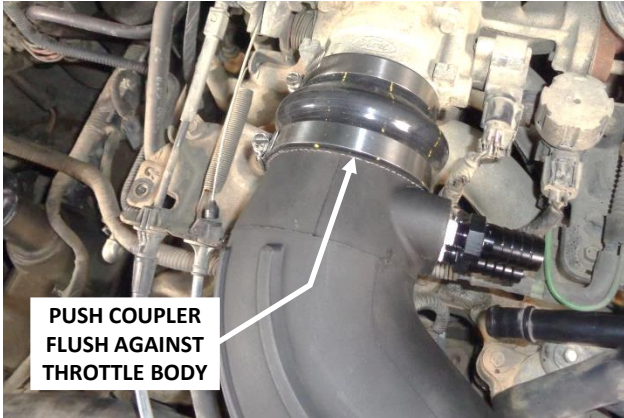

31. Push the flex coupler up against the throttle body and tighten only the throttle body clamp.

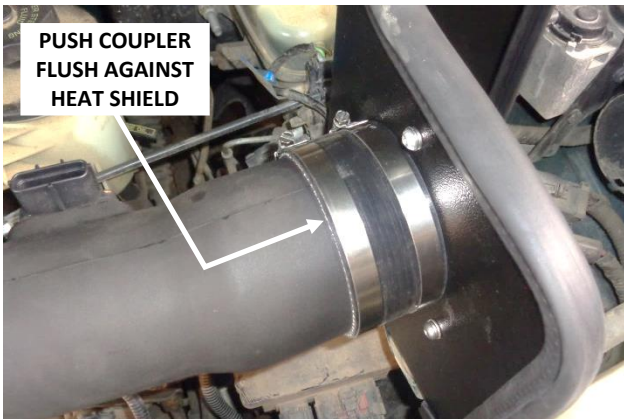

32. Push the straight coupler up against the heat shield and tighten only the filter adapter clamp.

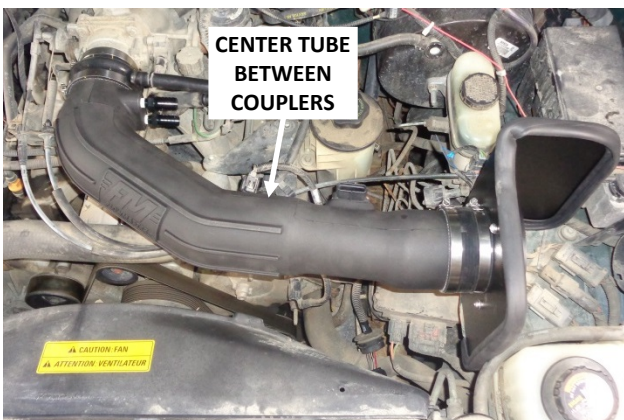

33. Center the intake tube between the couplers (so that there is roughly an equal amount of the tube inside each coupler). Then tighten the two intake tube clamps.

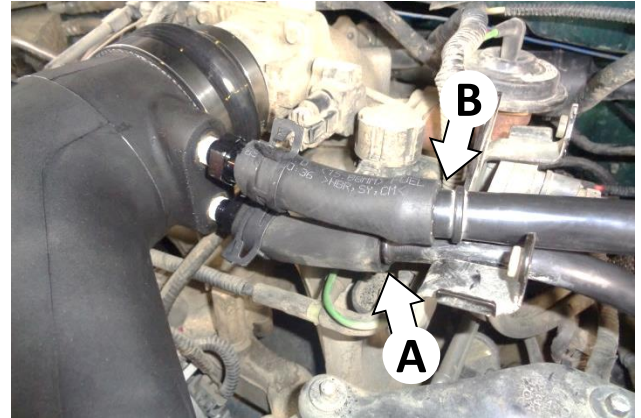

34. **ON 5.4L ENGINES:** Push the 5/8" hose (16) onto the lower tube (A), cut it to fit the barbed fitting, and secure it at both ends using 5/8" pinch clamps (15). Repeat the process on the upper tube (B) with the 3/4" hose (17) and pinch clamps (14).

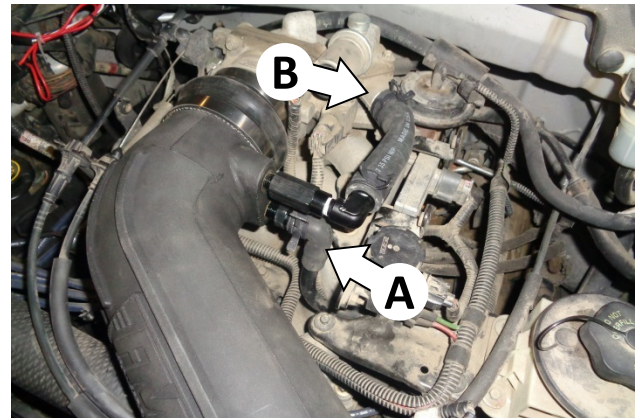

35. **ON 4.6L ENGINES:** Push the PCV elbow (A) onto the barbed fitting and secure it with a pinch clamp (15). Push the 3/4" hose (17) onto the throttle body (B), cut it to fit the barbed elbow, and secure the hose at both ends with 3/4" pinch clamps (14).



36. Connect the air temp sensor plug to the sensor and check the plug for security.



37. Push the MAF sensor plug onto the sensor until the locking tab clicks, then check the plug for security.



38. Place screw clamp (2) on air filter (1), install the filter on the filter adapter, and tighten the clamp.

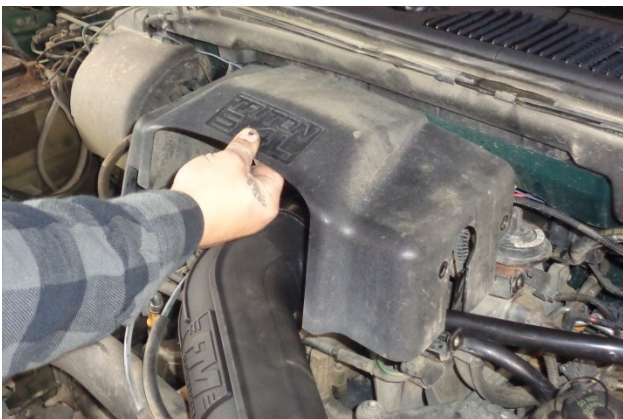

39. Reinstall the engine appearance cover, and secure it with its 3 screws.

**FLOWMASTER** CARB EO #  
THE PERFORMANCE TECHNOLOGY COMPANY

**DELTA FORCE PERFORMANCE INTAKE**

**D-698-5**

**FLOWMASTER INC. • 866-464-6553**  
1801 RUSSELLVILLE ROAD, BOWLING GREEN, KY 42101

40. Affix the CARB Exemption Order label to a clean, readily-visible location under the hood (e.g., near the hood latch), so an inspector can easily see it at emissions testing.



**Congratulations, the installation of your FLOWMASTER performance air intake kit is now complete!**

#### VECI LABEL NOTE

California emissions law requires the Vehicle Emission Control Information (or VECI ) label to be readily-visible in the engine compartment.

If your VECI label is affixed to the stock airbox, a replacement label must be obtained and affixed to a suitable location in the engine compartment.

Replacement VECI labels can be ordered from the dealership by VIN number. The VECI label should be affixed somewhere that is NOT easily removed from the vehicle.

**NOTE: A missing VECI label may result in failure of the vehicle's emissions test.**

