

MSD INSTALLATION INSTRUCTIONS

MSD Cap and Rotor for Early, Non-vented GM LT-1 Engines PN 8481

Parts Included:

1 - Cap	2 - Seals	1 - 8-32 x 1.125 Phillips Screw
1 - Rotor	1 - Vacuum Line Assembly	1 - Clamp-Block
1 - Isolator	4 - 3.5mm x 6mm Phillips Screws	1 - Removal Tool
2 - Rotor Screws		

IMPORTANT: Due to the number of applications and years that the LT-1 Cap and Rotor are used on, it is highly recommended to have the Service Manual for your vehicle during this installation. This Cap and Rotor Kit is supplied with a vacuum line assembly to vent the cap. This helps prevent ozone and moisture build-up within the distributor cap.

DISASSEMBLY

1. Disconnect the negative battery cable.
2. Locate the radiator petcock and drain the coolant from the system.
3. Disconnect the MAF and IAC sensors. Remove the air intake ductwork and the MAF sensor.
4. Once the coolant is drained, remove the upper radiator hose from the thermostat housing.
5. Loosen the three bolts that secure the crankshaft pulley/hub assembly. Do not remove them entirely at this time.
6. Remove the accessory drive belt by moving the spring loaded idler pulley. Use caution as this pulley is spring loaded! The belt will slide off the pulley system and the idler pulley will settle beyond its installed position.
7. Once the belt is removed, proceed with removing the pulley from the crankshaft hub by pulling the three retaining bolts.
8. It may be necessary to remove the cooling fan. This is done by removing the four bolts and disconnecting the wiring connection.
9. Disconnect the air pump power wires and remove the air pump from its mounting brackets.
10. Disconnect the coolant temperature wiring sensor located on the water pump.
11. Loosen the lower radiator hose clamp and the two heater hose clamps at the water pump. Coolant will generally still pour out of the hoses and water pump.
12. To remove the water pump, the power steering pump may need to be removed. With a shorter extension, the water pump bolt should be able to be accessed. There are five water pump bolts. Once again, more coolant may spill out.
13. At this point, you should be able to access the distributor cap. Mark the location of each spark plug wire before removing them.
14. Using the supplied special tool and a 1/4" wrench, remove the four screws that hold the distributor cap to the engine and pull the cap off (Figure 1).
15. Note the position of the rotor, optical disk and shims. These must be installed in the same position with the new rotor. Remove the two rotor screws and pull the rotor off. At this time, the isolator assembly will slide off the housing.
16. Now is a good time to visually inspect and clean the distributor for excessive wear.

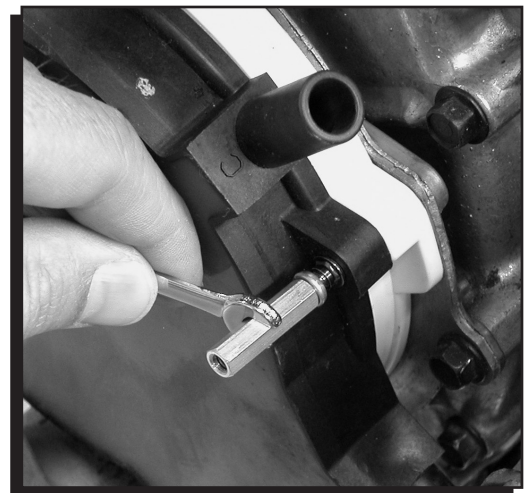

Figure 1 Removing the Original Cap.

INSTALLATION

Before proceeding, you will need to seal the distributor housing's original vent holes. These are located at the bottom of the distributor housing (Figure 2). Use a silicone gasket sealer or equivalent.

1. Locate and install the distributor-to-isolator seal then position the isolator in place on the distributor (Figure 3). Note the fresh air inlet port on the isolator (Figure 4).
2. Make sure the optical disk and shims are installed in the right position, then install the new rotor with the supplied hardware. The rotor only installs one way. Make sure it sits squarely on the shaft.

Note: It is recommended to use a threadlocker like Loctite Blue on the two rotor screws.

3. Make sure that the Isolator-to-Cap seal is installed on the Isolator, then install the cap using the supplied Phillips head screws.
4. Locate four metric Phillips screws that retain the cap assembly. There is also a standard, slightly larger and longer Phillips screw. This screw is used with the Clamp-Block that goes in the cap tab located between the wiring harness and the coil wire tower (Figure 5).
5. Note that the Clamp-Block has two different thicknesses (Figure 6). Some distributor housings have a machined surface while others are cast. Determine which side works best in your application to secure the top mount of the cap. Once the direction is achieved, slide the Clamp-Block into position and screw the standard Phillips screw into position (Figure 6).
6. Connect the distributor connector followed by the coil wire and spark plug wires. Ensure that each wire is in the correct location (Figure 10).
7. Install Vacuum hoses as shown on page 3 (Figures 7 - 9).
8. The distributor is assembled. Reinstall all of the components in the reverse order. It is recommended to follow along with your vehicle's service manual.

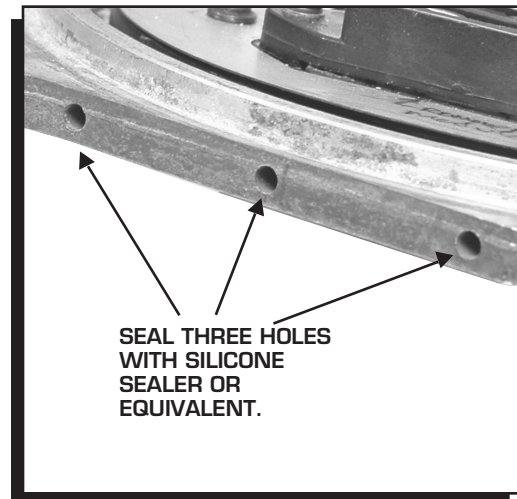

Figure 2 Sealing the Vent Holes.

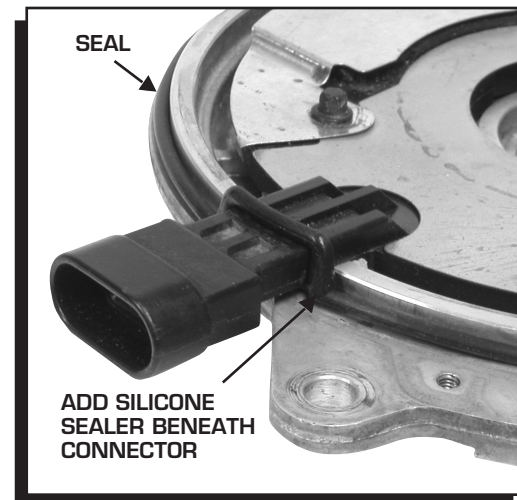

Figure 3 Installing the Distributor-to-Isolator Seal.



Figure 4 Isolator Inlet.



Figure 5 Clamp-Block Mounting Boss.

VACUUM LINE ROUTING

This kit is supplied with a vacuum line kit that will aid in venting the distributor cap. One hose assembly connects to a vacuum port on the intake manifold while the other line connects to the air inlet going into the throttle body. In order to take advantage of this venting technique, you will need to seal the three small holes on the bottom of the distributor (Figure 2).

1. Connect the long hose assembly to the lower vacuum inlet of the MSD distributor cap (Figure 7). Use the supplied clamp to secure the hose.
2. Route the vacuum line around the side of the engine and up to the intake manifold. Splice into the hose that connects just over the PCV valve (Figure 8). Also note the check valve that is in-line. The black side of the valve must face towards the vacuum source.
3. Connect the smaller vacuum line to the fresh air inlet port of the isolator (see Figure 4).
4. Locate the supplied 90° vacuum nipple. Using a 3/16" drill bit, drill a hole in the air intake duct and install the nipple (Figure 9). Make sure the barb goes through and into the duct. Connect the line from the distributor cap to this inlet. This line completes the fresh air circulation through the distributor cap (Figure 11).
5. Install the spark plug wires ensuring they are routed to the correct terminal (Figure 10).

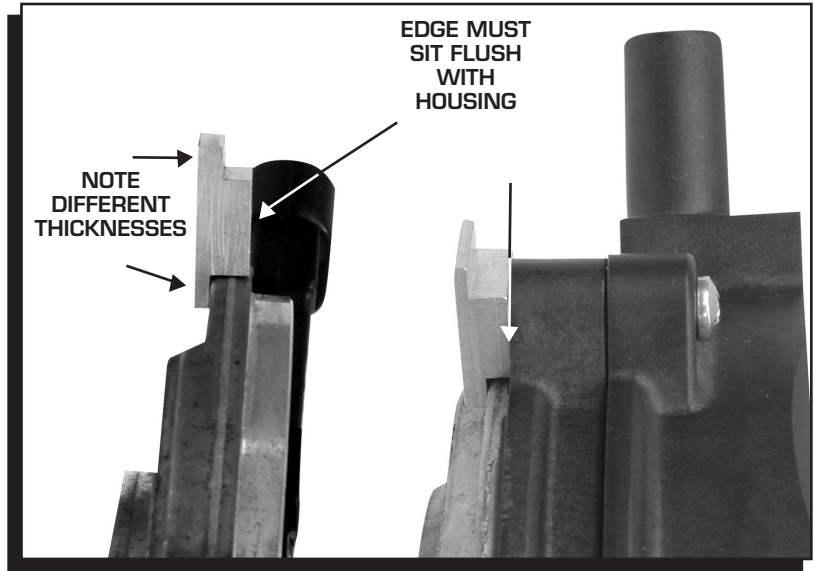

Figure 6 Installing the Clamp-Block.

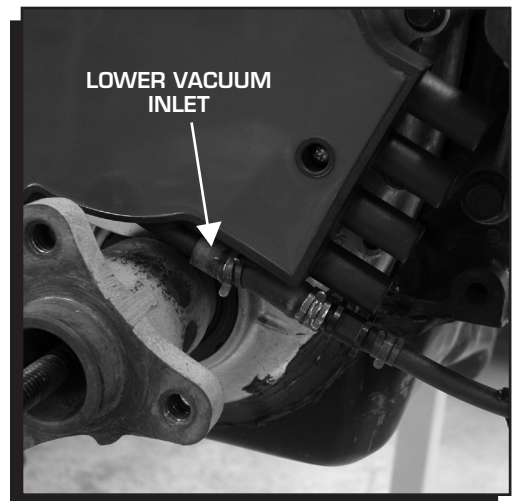

Figure 7 Install the Lower Vacuum Line.

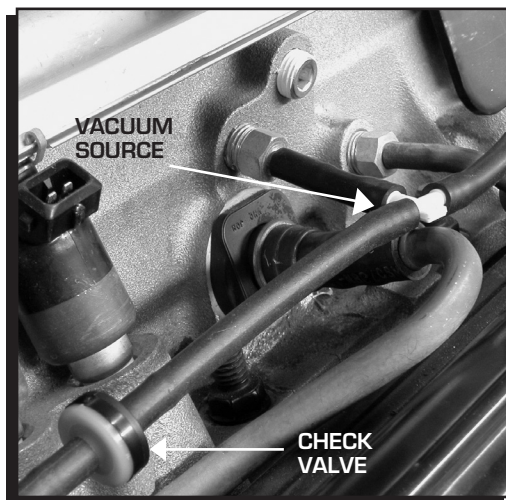

Figure 8 Connecting the Vacuum Source.

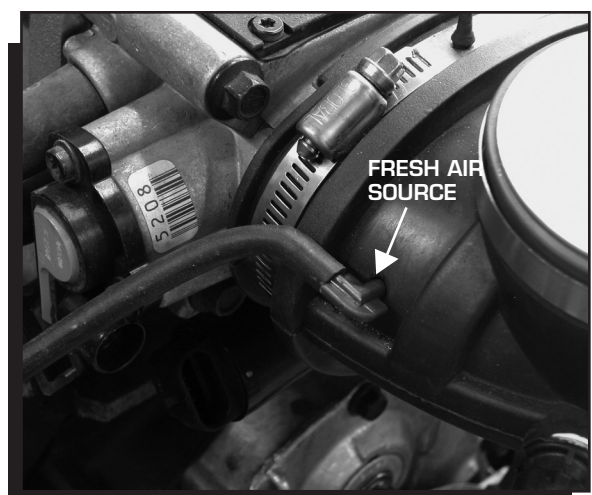

Figure 9 Installing the Fresh Air Line.

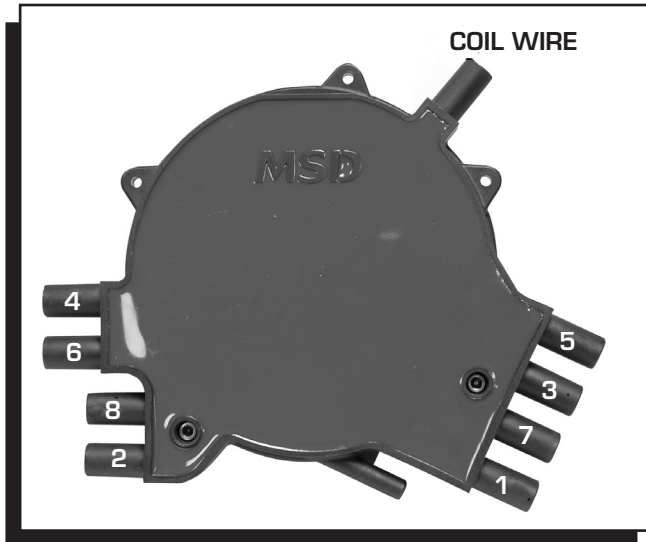

Figure 10 Spark Plug Wire Location.

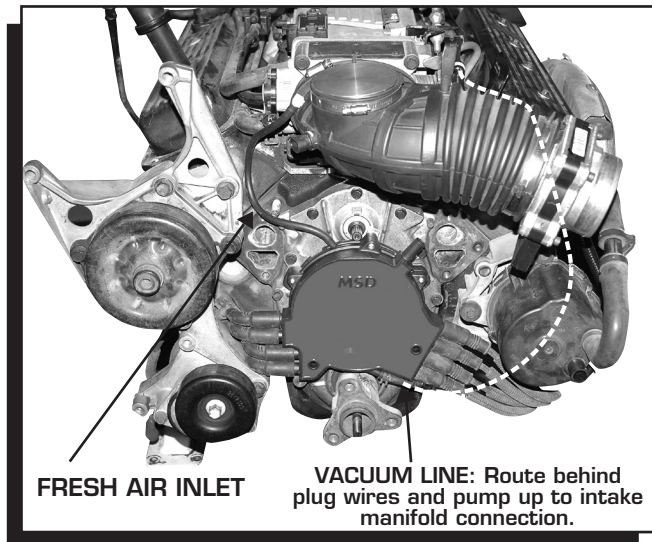

Figure 11 Fresh Air Hose Routing.

TECH NOTES

Service

In case of malfunction, this MSD component will be repaired free of charge according to the terms of the warranty. When returning MSD components for warranty service, **Proof of Purchase** must be supplied for verification. After the warranty period has expired, repair service is based on a minimum and maximum fee.

All returns must have a Return Material Authorization (RMA) number issued to them before being returned. To obtain an RMA number please contact MSD Customer Service at 1 (888) MSD-7859 or visit our website at www.msdpower.com/rma to automatically obtain a number and shipping information.

When returning the unit for repair, leave all wires at the length in which you have them installed. Be sure to include a detailed account of any problems experienced, and what components and accessories are installed on the vehicle. The repaired unit will be returned as soon as possible using Ground shipping methods (ground shipping is covered by warranty). For more information, call MSD at (915) 855-7123. MSD technicians are available from 7:00 a.m. to 5:00 p.m. Monday - Friday (mountain time).

Limited Warranty

MSD warrants this product to be free from defects in material and workmanship under its intended normal use*, when properly installed and purchased from an authorized MSD dealer, for a period of one year from the date of the original purchase. This warranty is void for any products purchased through auction websites. If found to be defective as mentioned above, it will be repaired or replaced at the option of MSD. Any item that is covered under this warranty will be returned free of charge using Ground shipping methods.

This shall constitute the sole remedy of the purchaser and the sole liability of MSD. To the extent permitted by law, the foregoing is exclusive and in lieu of all other warranties or representation whether expressed or implied, including any implied warranty of merchantability or fitness. In no event shall MSD or its suppliers be liable for special or consequential damages.

*Intended normal use means that this item is being used as was originally intended and for the original application as sold by MSD. Any modifications to this item or if it is used on an application other than what MSD markets the product, the warranty will be void. It is the sole responsibility of the customer to determine that this item will work for the application they are intending. MSD will accept no liability for custom applications.